

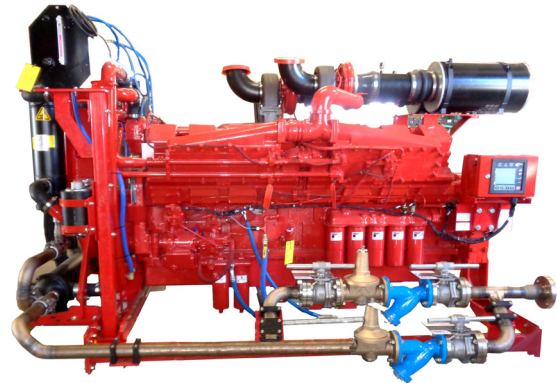

Specification sheet

Fire pump drive engine

CFP50-F60



Description

Engine series - Cummins KTA50 Series

Modeled after the Cummins KTA50 generator drive engine, the rugged CFP50 has the proven mechanical pressure-time (PT) fuel system with a Woodward hydraulic governor. It has demonstrated its reliability in several applications with many configurations custom-designed for the oil and gas industry.

Features

Certified power - The CFP50-F60 complies with NFPA 20.

Control system - The industry-leading, state-of-the-art Fire Pump Digital Panel (FPDP) provides total fire pump drive engine system integration and intuitive operation, including:

- Color touchscreen;
- Dual microprocessors for critical signal redundancy; and
- Optional Modbus field server remote messaging capability.

Warranty and service - Our models are backed by a comprehensive warranty and worldwide distributor network.

Operating speed (RPM)	Ratings in HP (kW)			
	1760		1800	
CFP50-F60	1705	(1272)	1736	(1295)

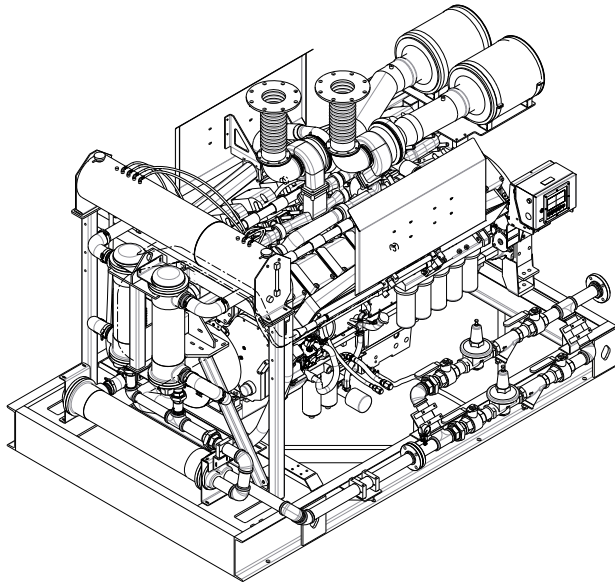

General engine data	
Engine type	4 Cycle; Vee, 16 Cylinder
Aspiration	Turbocharged and Low-temperature After-cooled
Bore and stroke	6.25 x 6.25 in. (159 x 159 mm)
Displacement	3067 in ³ (50.3 L)
Rotation	Counterclockwise
Compression ratio	13.9:1
Valves per cylinder	Intake - 2 Exhaust - 2
Fuel system	Cummins Pressure-Time (PT)
Maximum allowable bending moment @ rear face of block	4500 lb.-ft. (6100 N-m)
Estimated wet weight*	16,650 lbs. (7552 kg)

* Weight includes engine, cooling loop, heat exchanger, dual Electronic Control Modules (ECMs), Fire Pump Digital Panel (FPDP), standard air cleaner, standard exhaust flex, and all fluids.

Equipment	Standard	Optional
Air cleaner	(2) Direct-mounted, one-stage industrial	(3) Direct-mounted, two-stage industrial
Alternator	24V-DC, 35 amps; includes European Union (EU) belt guard	N/A
Cooling loop (maximum pressure of 200 PSI)	2 1/2" diameter for fresh water	Cu Ni construction available for sea water applications
Cooling system	60 PSI with flange connections, tube and shell type	Radiator
Engine heater	(2) 240V-AC, 4000 watts	(2) 480V-AC, 4000 watts
Exhaust protection	Metal guards on manifolds and turbocharger	N/A
Exhaust flex connection	Steel, flanged	Stainless steel flex, NPT
Flywheel power take-off	Flywheel	Driveshaft system
Fuel connections	Fire-resistant flexible supply and return lines	N/A
Fuel filter	Dual spin-on fuel filters with standard water separators	N/A
Governor, speed	Constant speed, Woodward	N/A
Fire pump digital panel (FPDP)	7" color touchscreen; enclosure rated as Type 2/Type 4X; Imperial and metric values	Optional 316SS construction; custom gauges with digital panel expansion module (DPEM)
Lube oil cooler	Engine-water-cooled, plate type	N/A
Lube oil filter	Spin-on, full-flow filter	N/A
Lube oil pump	Gear-driven	N/A
Manual start controls	On FPDP and/or contactors	N/A
Overspeed controls	Electronic with reset and test on FPDP	N/A
Starter	(2) 24V-DC	Pneumatic*/hydraulic*

*Only approved as a secondary starter

Air induction system

Maximum temperature rise between ambient air and engine air inlet	30 °F (16.7 °C)
Maximum inlet restriction with dirty filter	25 in. H ₂ O (635 mm H ₂ O)
Recommended air cleaner element - (standard)	(2) Cummins Filtration AH19076

Lubrication system

Oil pressure range at rated	50-70 PSI (345-483 kPa)
Oil capacity of pan (high - low)	160-128 qt. (152-122 L)
Total system capacity	54 gal. (204 L)
Recommended lube oil filter	(5) Cummins Filtration LF3325

Cooling system*

Raw water working pressure range at heat exchanger	60 PSI (413 kPa) MAX
Recommended minimum water supply pipe size to heat exchanger	2.50 in. (63.50 mm)
Recommended minimum water discharge pipe size from heat exchanger	3.00 in. (76.20 mm)
Coolant water capacity (engine only)	76.5 gal. (289.6 L)
Standard thermostat - type	Modulating
Standard thermostat - range	180-200 °F (82-93 °C)
Normal operating temperature	180-212 °F (82-100 °C)
Minimum raw water flow:	
- with water temperatures to 60 °F (16 °C)	70 GPM (4.42 L/sec)
- with water temperatures to 80 °F (27 °C)	85 GPM (5.36 L/sec)
- with water temperatures to 100 °F (38 °C)	100 GPM (6.31 L/sec)
Recommended cooling water filter	(2) Cummins Filtration WF2076

* A jacket water heater is mandatory on this engine. The recommended heater wattage is (2) 4000 down to 40 °F (4 °C)

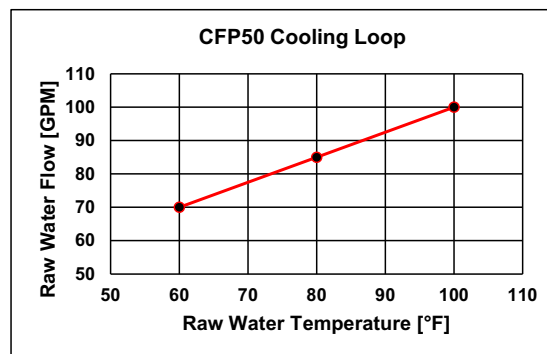

Exhaust system

Maximum allowable back pressure by complete exhaust system	27.2 in. H ₂ O (6.8 kPa)
Exhaust pipe size normally acceptable	12 in. (305 mm)

Noise emissions - The noise emission values are estimated sound pressure levels at 3.3 ft. (1 m).

Top	105 dBa
Right side	103 dBa
Left side	104 dBa
Front	101 dBa
Exhaust	127 dBa

Fuel supply/drain system

Operating speed in RPM	1760		1800	
	Fuel rate - gal/hr (L/hr)	81.6 (309.1)	83.1 (314.7)	
Fuel type	No. 2 diesel only			
Minimum supply line size	1.5 in. (38.10 mm)			
Minimum drain line size	1 in. (25.40 mm)			
Maximum fuel line length between supply tank and fuel pump	40 ft. (12 m)			
Maximum fuel height above C/L fuel pump	84 in. (2134 mm)			
Recommended fuel filter - primary	(2) Cummins Filtration FS1006			
Recommended fuel filter - secondary	None			
Maximum restriction @ lift pump-inlet - with clean filter	4 in. Hg (102 mm Hg)			
Maximum restriction @ lift pump-inlet - with dirty filter	8 in. Hg (203 mm Hg)			
Maximum return line restriction - without check valves	6.5 in. Hg (165 mm Hg)			
Minimum fuel tank vent capability	15 ft ³ /hr (.45 m ³ /hr)			
Maximum fuel temperature @ lift pump inlet	160 °F (71 °C)			

Starting and electrical system

Minimum recommended battery capacity - cold soak at 0 °F (-18 °C) or above	24V
Engine only - cold cranking amperes	1800 CCA*
Engine only - reserve capacity	460 minutes*
*Based on FM requirement for a minimum of 900 CCA and 430 reserve capacity minutes	
Battery cable size - minimum of 2/0 AWG and maximum cable length not to exceed 6 ft. (1.5 m)	24V
Maximum resistance of starting circuit	0.002 Ohms
Typical cranking speed	150 RPM
Alternator (standard), internally regulated	35 amps

Operating conditions

Operating speed in RPM	1760		1800	
	Output - BHP (kW)	1705 (1271)	1736 (1295)	
Ventilation air required - CFM (litre/sec)	3484 (1644)	3739 (1765)		
Exhaust gas flow - CFM (litre/sec)	8158 (3850)	9050 (4272)		
Exhaust gas temperature - °F (°C)	816 (435)	816 (435)		
Heat rejection to coolant - BTU/min. (kW)	50561 (889)	51071 (897)		
Heat rejection to ambient - BTU/min. (kW)	9305 (164)	9534 (168)		

Engine performance for CFP50-F60

Torque Output

RPM	lb-ft	N-m
1760	5088	6898
1800	5065	6868

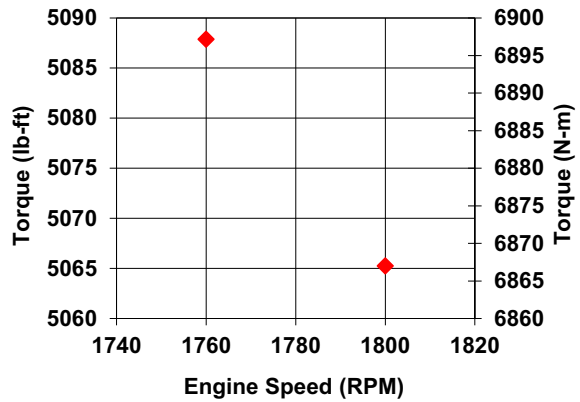

Horsepower Output

RPM	BHP	kW
1760	1705	1271
1800	1736	1295

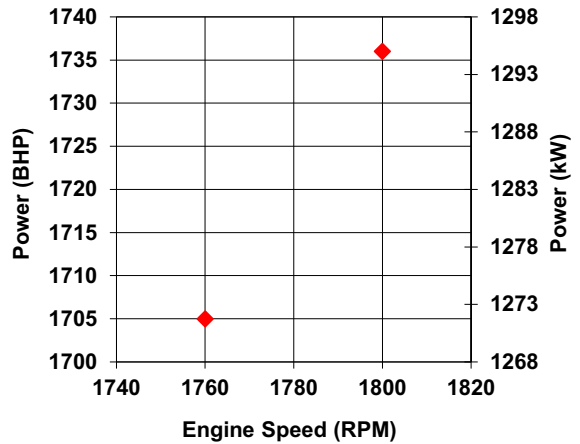

All data is based on the engine operating with a fuel system, water pump, lubricating oil pump, air cleaner, and alternator. The fan, optional equipment, and driven components are not included. Data is based on operation at SAE standard J1349 conditions of 300 ft. (91.4 m) altitude, 29.61 in. (752 mm) Hg dry barometer, and 77 °F (25 °C) intake air temperature, using No.2 diesel fuel only.

Altitude above which output should be limited*:	300 ft. (91.4 m)
Correction factor per 1000 ft. (305 m) above altitude limit:	3%
Temperature above which output should be limited:	77 °F (25 °C)
Correction factor per 10 °F (11 °C) above temperature limit:	1% (2%)

* Above 5,000 feet, contact Cummins for derate information.

Fire pump digital panel (FPDP)



The Cummins FPDP is an integrated microprocessor-based control system that provides full digital technology with enhanced accuracy and built-in redundancy.

Reliable design - Designed and tested with isolated mounting to minimize vibration for longer life and durability, the Cummins FPDP proves reliable in harsh environments.

Advanced control methodology - The Cummins FPDP allows for Input/Output (I/O) expansion and remote monitoring capabilities.

Certified quality - The Cummins FPDP is UL 1247 Listed and FM 1333 Approved.

Operator panel features

- 7" TFT LCD (thin-film-transistor liquid-crystal display) - color, 24-bit, 800x480 (WVGA).
- Auto, manual, start, stop, and fault reset.
- Assembly enclosure that meets NEMA Type 2 and Type 4X design requirements and is water, corrosion, fire, and impact-resistant.
- Optional RS-485 serial - Modbus RTU/Modbus TCP/IP.
- **Other control feature** - Digital Panel Expansion Module (DPEM) for additional analog/digital inputs and configurable dry relay contact output.

Functional

- Configurable display units for temperature in degrees Fahrenheit or Celsius and pressure in PSI or kPa.
- Ability to crank the fire pump drive engine from Battery A, Battery B, or both.
- Overspeed shutdown.

Environmental

- Operating temperature: minus 4 to 140 °F (minus 20 to 60 °C).
- Storage temperature: minus 22 to 176 °F (minus 30 to 80 °C).
- Meets CISPR 11 Class B radiated emissions.

Electrical

- 8-30 VDC operating voltage.
- Reverse polarity protected.
- Spring cage terminal block interface.
- Built-in dual micro controllers for increased reliability.

Mechanical

- 1 3/8" pre-cut customer conduit knockout for easy field installation.
- Simplified internal design for efficiency and ease of customer connections.
- 16GA ASTM A366 material - 316 stainless steel optional.
- RAL3001 red powder coat finish.

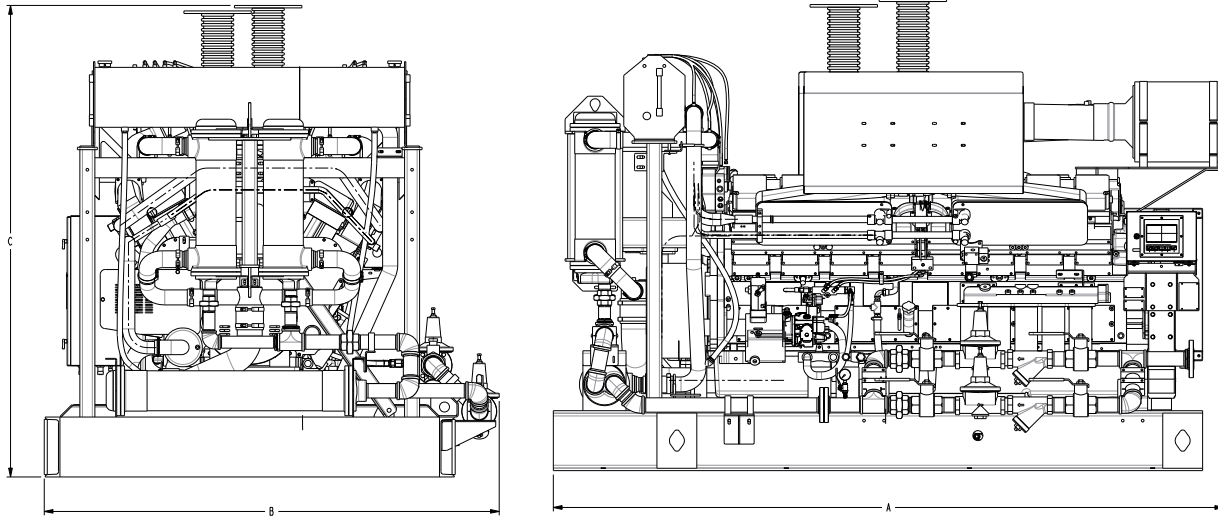

This outline drawing is for reference only.
Do not use for installation design.

	Dim "A" in. (mm)	Dim "B" in. (mm)	Dim "C" in. (mm)
CFP50	134 (3404)	91 (2313)	94 (1643)

NOTE: Consult drawings or contact the factory for additional information.

NOTE: Specifications are subject to change without notice.
For more information, contact firepumpsales@cummins.com.

ISO 9001:2015

This product has been manufactured under the controls established by an approved management system that conforms with ISO 9001:2015.



Cummins Inc.
Box 3005
Columbus, IN 47202-3005
U.S.A.

1-800-CUMMINS™ (1-800-286-6467)
cummins.com

Printed in U.S.A.
©2022 Cummins Inc.